

# BoMetals, inc.®

concrete and masonry accessories

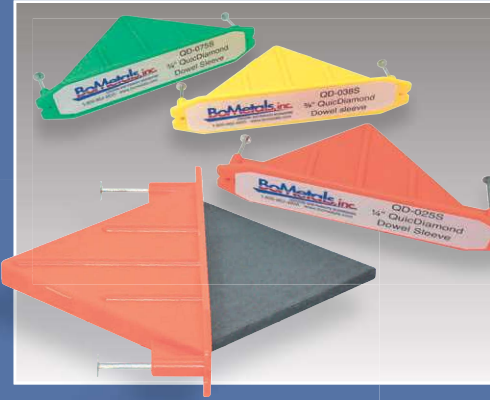

Waterstops  
Keyway  
Dowel Systems  
Accessories

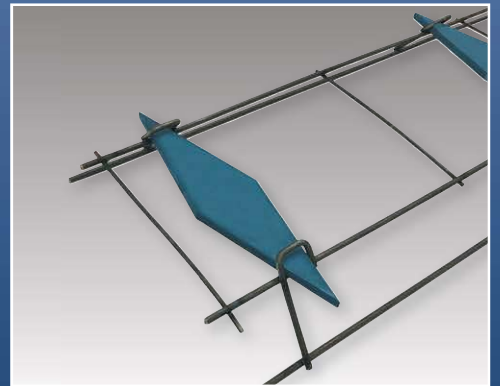
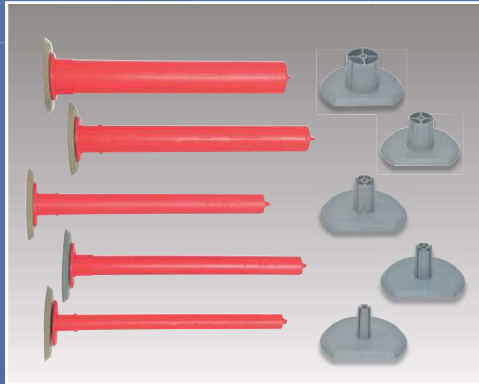

MANUFACTURED IN  
Carrollton, Georgia USA



DISTRIBUTED WORLDWIDE



## WELCOME TO BOMETALS

Since 1989, BoMetals has earned a reputation in the concrete and masonry accessory market for continuous innovation, enthusiastic customer service and dedication to the construction industry.

BoMetals serves the concrete accessory market by manufacturing a wide variety of products used in both commercial and residential construction. These products include a comprehensive offering of PVC and TPER Waterstop to meet the needs of any job. We also supply Mastic and Hydrophilic Waterstops.



BoMetals is also the nations top manufacturer of keyold joint systems. They include QuickKey™, the only galvanized joint system that features square dowel knockouts and Pro-Key™, with a patented positive stake-to-key interlock. Other concrete products include Keyway Caps, Expansion Board Caps, Zip Joint, Chamfer and Radius Formers plus much more.



BoMetals also serves the masonry market with a complete line of PRO-SLOT™ and Dovetail Anchors, and Control Joint which are available in PVC and Rubber. We also manufacture Block Cap & Weep Tubes.

All BoMetals products are available through a national network of distributors and warehouses. A trained and knowledgeable sales or engineering staff offer personalized service unparalleled in the industry today.

Sincerely,



Direct access to BoMetals.com



## LIMITED WARRANTY AND LIMITATION ON LIABILITY

BoMetals, inc warrants that each product described herein shall be free from defects in materials and workmanship, ordinary wear and tear excepted, for one year from the date of delivery thereof, provided that such product is used and installed properly and is not interchanged or used with the products of other manufacturers. BoMetals' sole obligation, and buyer's exclusive remedy, under this warranty shall be limited to, at BoMetals' option, full refund of the purchase price of the nonconforming product or replacement of the nonconforming product. For full details on our warranty, please contact us at 800-862-4835

## PRODUCT SELECTION DISCLAIMER

BoMetals is happy to assist in your product selection; However, BoMetals disclaims any responsibility for the selection of a particular product. Product selection is the sole responsibility and decision of the buyer. The suitability of any material for a specific application requiring fluid resistance is best determined by specific testing for the application. BoMetals urges the Buyer to conduct its own testing.

## RETURN/CANCELLATION POLICY

Any return must have a Return Goods Authorization Number (RGA#). BoMetals will only issue credit for what is received with a RGA# and found to be in resalable condition within 90 days from invoice date. 20% restocking fee applies & return freight is prepaid by shipper. BoMetals cannot issue credit for damaged or lost items during transit. Purchase Orders cannot be cancelled for any custom item after the manufacturing process has begun.

For full details on Return/Cancellation Policy, please call 800-862-4835.





## PVC WATERSTOPS

### TYPES OF CONCRETE JOINTS

#### Expansion (Isolation) Joint

A joint that separates the slab structurally from other building elements such as walls, columns, foundations, drain pipes, to accommodate differential horizontal and vertical movement.

#### Contraction (Control) Joint

A formed, sawed or tooled groove in a concrete structure to create a weakened plane and regulate the location of cracking resulting from the dimensional change of different parts of the structure.

#### Construction Joint

A joint placed in concrete where construction operations are concluded for the day.

—Reprinted with permission, American Concrete Institution, CCS-1, Slabs on Grade, Mary K. Hurd, Editor.

### WATERSTOPS FOR MOVING JOINTS

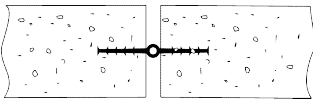

#### Ribbed Center Bulb

Used in expansion joints where normal movement between members is anticipated. **Also available in split shapes.**

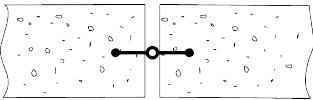

#### Dumbbell with Center Bulb

Used in expansion joints where longitudinal and transverse movement is anticipated.

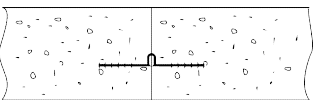

#### Tear Web

Used in expansion joints where large joint movements are expected.

### RETROFIT APPLICATIONS

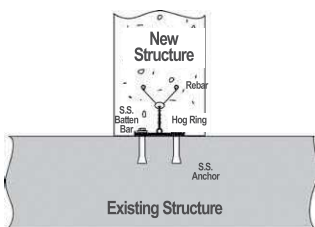

Used to provide a watertight seal when attaching a new construction project to an existing one.

### WATERSTOPS FOR NON OR LIMITED MOVEMENT JOINTS

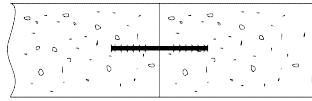

#### Flat Ribbed

Used in construction joints where little or no movement is anticipated and where high bond strength is desired.

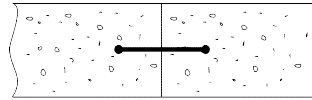

#### Dumbbell

Used in construction joints where little or no movement is anticipated. **Also available in split shapes.**

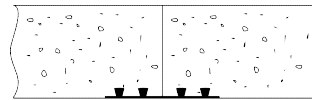

#### Base Seal

Used in grade construction between concrete walls and slabs, in backfilled retaining walls and in keyed construction joints in walls and slabs.

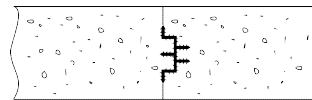

#### Multi Rib

Used in construction joints in vertical applications where key action is desired.

### TYPICAL PROPERTIES OF PVC WATERSTOPS MEET OR EXCEED CRD-C 572-74, 100% VIRGIN RESIN

Typical Properties	Minimum Value	ASTM
Water Absorption, %	0.15 max	D-570
Tear Resistance, lb/in (kg/cm)	300 (53.5)	D-624
Specific Gravity, (+/-0.05)	1.38	D-792
Hardness, Shore A (+/-5, 10 sec. delay)	80	D-2240
Tensile, psi (kg/cm <sup>2</sup> )	2000 (140.6)	D-638, Type IV
Elongation, %	350	D-638, Type IV
Low Temperature Brittleness, °F (°C)	-35(-37) Passed	D-746
Stiffness in Flexure, psi (kg/cm <sup>2</sup> )	600 (42.1)	D-747
<b>Accelerated Extraction, CRD-C 572</b>		
Tensile, psi (kg/cm <sup>2</sup> )	1600 (112.4)	D-638, Type IV
Elongation, %	300	D-638, Type IV
<b>Effect of Alkali, CRD-C 572</b>		
Weight Change, %	-0/+0.25	-----
Change in Hardness, %	+/-5	D-2240

IMPORTANT: The technical data herein is believed to be accurate. It is offered for your consideration, investigation and verification. All testing and test data has been prepared by independent laboratories. NO WARRANTY, EXPRESS OR IMPLIED, IS MADE as to the accuracy or completeness of the technical data herein and the use thereof for any particular purpose.

# PVC WATERSTOPS

Available in TPER

## RIBBED CENTER BULB

Catalog Number	Head Pressure	Lbs./ LF	Profile
RCB-4316	65'	.40	
RCB-4316CA	65'	.50	
RCB-4316LB	65'	.74	
RCB-4316NT	65'	.60	
RCB-6316	100'	.73	
RCB-6316A	100'	.92	
RCB-6316NT	100'	.86	
RCB-6316T	100'	.68	
RCB-612	150'	1.90	
RCB-614	100'	.98	
RCB-638	125'	1.16	
RCB-638BR	125'	1.19	

Catalog Number	Head Pressure	Lbs./ LF	Profile
RCB-638LB	125'	1.63	
RCB-638NT	125'	1.55	
RCB-912	200'	2.42	
RCB-9316	100'	1.20	
RCB-938	175'	1.76	
RCB-938BR	175'	2.65	
RCB-938LB	175'	2.25	
RCB-938NT	175'	2.45	
RCB-938VLB	150'	2.73	
RCB-1212	225'	4.32	
RCB-1212T	225'	3.60	
RCB-12316	150'	1.56	



# PVC WATERSTOPS

Available in TPER

## FLAT RIBBED

Catalog Number	Head Pressure	Lbs./ LF	Profile
FR-4316	65'	.45	
FR-6316	75'	.81	
FR-638	125'	1.50	
FR-638RT	125'	1.70	
FR-638T	125'	1.30	
FR-9316	100'	1.20	
FR-938	175'	2.37	
FR-938T	175'	2.07	

## SPLIT RIBBED CENTER BULB

Catalog Number	Head Pressure	Lbs./ LF	Profile
SR-4316	65'	.52	
SR-6316	100'	.75	
SR-638	125'	1.54	
SR-938	150'	2.04	
SR-1212	200'	3.18	

## DUMBELL

Catalog Number	Head Pressure	Lbs./ LF	Profile
DB-4316	65'	.49	
DB-6316	75'	.71	
DB-6316LB	75'	.93	
DB-614	100'	1.11	
DB-638	125'	1.59	
DB-9316	100'	1.17	
DB-938	150'	2.17	
DB-938LB	150'	2.55	
DB-1238	200'	2.99	

## SPLIT DUMBELL

Catalog Number	Head Pressure	Lbs./ LF	Profile
SD-638	125'	1.51	
SD-938	150'	2.20	

## MULTI RIB

Catalog Number	Head Pressure	Lbs./ LF	Profile
MR-314	25'	.84	
MR-412	50'	1.24	

## PVC WATERSTOPS

Available in TPER

### RETRO FIT

Catalog Number	Head Pressure	Lbs./ LF	Profile
RF-4316	N/A	.89	
RF-638	N/A	2.15	
RF-912	N/A	4.84	
RFL-3316	N/A	.90	

### DUMBBELL WITH CENTER BULB

Catalog Number	Head Pressure	Lbs./ LF	Profile
DBCBC-614	100'	1.41	
DBCBC-638	100'	1.68	
DBCBC-938	150'	3.10	
DBCBC-938L	150'	3.70	

### RETRO FIT ACCESSORIES - EPOXY, SS BARS & BOLTS



### BASE SEAL

Catalog Number	Head Pressure	Lbs./ LF	Profile
BS-618	100'	.89	
BS-618CI	100'	1.07	
BS-718E	100'	1.16	
BS-72518	75'	.88	
BS-9316	100'	1.72	
BS-9532	100'	1.53	
BS-17532	N/A	2.75	
CU-912	N/A	4.53	

## PVC WATERSTOPS

### TEAR WEB

Catalog Number	Head Pressure	Lbs./ LF	Profile
CTW 1-2	35'	1.10	
TW-618	65'	.78	
TW-918	100'	1.00	
TW-938	150'	3.78	

## WATERSTOP ACCESSORIES

### FIELD SPLICING TOOLS



Dimensions: 2" x 14" x 1" (#SI-214)  
4 1/2" x 14" x 3/4" (#SI-414)

100% factory tested, adjustable temperature, heavy duty vinyl grip, teflon peel and stick cover, standard 110-120 VAC/8 Amp, 8' power cord, UL Listed. Additional Splicing Covers available.

Splicing Video



### HOG RING OR EYELET INSTALLATION

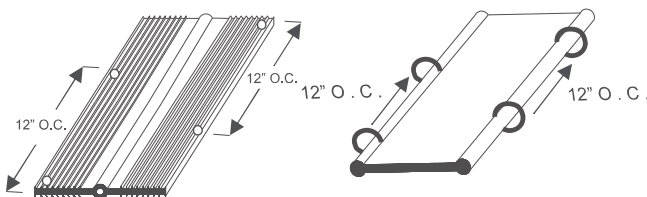

BoMetals can install Hog Rings or Eyelets to virtually any Waterstop profile. Please call 800-862-4835 for profile specific quotes.

We are also able to supply Hog Rings direct to you for field installation.

## WATERSTOP ACCESSORIES

### CUSTOM SPLICES

An important factor in the watertightness of any waterstop is the reliability of splices. With BoMetals fittings, you are guaranteed greater strength and efficiency with ease of field installation. The following factory made splices are available in PVC & TPER. BoMetals is also capable of manufacturing other custom splices specifically to fit your specifications.



Custom Fabrication Video

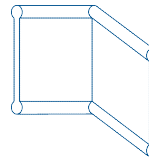

Vertical Ell

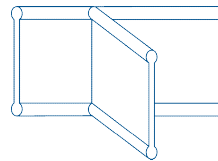

Vertical Tee

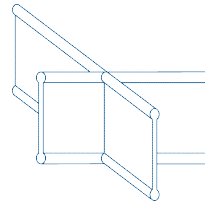

Vertical Cross

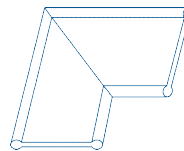

Flat Ell

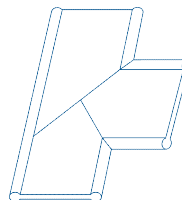

Flat Tee

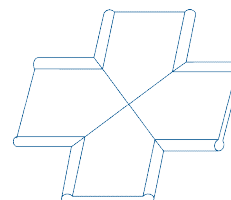

Flat Cross



## CHEMICAL RESISTANT WATERSTOP

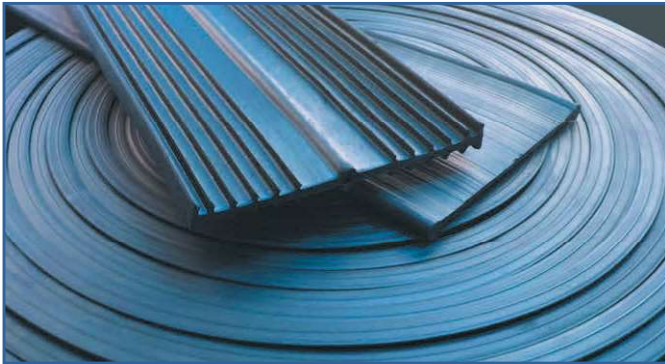

### TPER AVAILABLE IN EVERY PROFILE ON PAGE 3-9

Chemical Resistant Waterstop is available in virtually every PVC Profile. BoMetals TPER is made of a specially formulated Thermoplastic Vulcanizate which is fully cross-linked compound. TPER should be used to provide a fluid tight diaphragm in secondary and tertiary, above and below grade containment facilities. This is accomplished by offering a product for concrete expansion and construction joints that greatly expands its resistance to petro-chemical, solvents, aqueous acids, and chemicals listed as hazardous by the EPA. BoMetals many selections will allow precise waterstop design for each critical application. The physical design and the field installation adversities should be considered when specifying and designing waterstop installation.

### Physical Properties of TPER Waterstop

Properties	Nominal Value	ASTM
Hardness Shore A, ±3	90	D-2240
Specific Gravity	0.96	D-792
Tensile Strength, psi (MPa)	2300 (15.9)	D-412 D-1171
Elongation, %	530	D-412
Brittle Point, °F (°C)	-65 (-54)	D-746
Stress @ 100% Elongation, psi (MPa)	1000 (6.9)	D-638
Ozone Resistance	Passed with no cracking at 500 ppm	

IMPORTANT: The technical data herein is believed to be accurate. It is offered for your consideration, investigation and verification. Buyer assumes all risk of use, storage and handling of the product. NO WARRANTY, EXPRESS OR IMPLIED, IS MADE INCLUDING, BUT NOT LIMITED TO, IMPLIED WARRANTIES OR MERCHANTABILITY AND FITNESS FOR A PARTICULAR PURPOSE. Nothing contained herein shall be construed as a license to operate under or recommendation to infringe any patents.

### TPER Retro Fit Accessories Epoxy, SS Bars & Bolts



### Popular Chemical Resistant Profiles

TCB-4316	
TCB-4316NT	
TCB-6316	
TCB-6316NT	
TCB-638LB	
TDB-4316	
TDB-6316	
TDB-638	
TFR-4316	
TFR-638	
TSR-6316	

BOMETALS CAN MANUFACTURE CHEMICAL RESISTANT WATERSTOP FROM VIRTUALLY ANY PROFILE ON PAGES 4-7

PAVING CAP SEAL

# B-SEAL PAVING CAP SEAL

B-SEAL is one of the most advanced Paving Cap Seal System in the industry. BoMetals uses specially formulated PVC to provide a durable sealing system for a maintenance free joint.

- Same continuous look throughout joint
- Protects against debris
- Can be used in the screeding process
- Also available in TPER

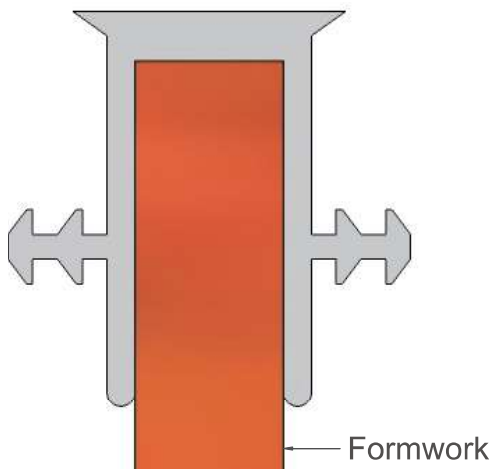

Typical Properties	Nominal Value	ASTM Method
Tensile Strength, psi	2500 min	D-412
Elongation, %	300 min	D-412
Hardness Shore A, $\pm 3$	85	D-2240
Oil Swell, Change in Volume/Weight ASRM #3 Oil, 70 hrs. @212F	$\pm 10\%$ by volume max. $\pm 15\%$ by weight max.	D-471
Abrasion Resistance 10,500 cycles, 1000 grams load	Material Loss - 0.4 gms. max.	D-3884
Ozone Resistance, 20% Strain 300 pphm, 70 hrs. @ 104F	No Cracking	D518
Results After Heat Aging	Tensile Strength Retained: 90% min. Elongation Retained: 90% min. Hardness Changes: 3%	D-573

IMPORTANT: The technical data herein is believed to be accurate. It is offered for your consideration, investigation and verification. Buyers assume all risk of use, storage and handling of the product. NO WARRANTY, EXPRESS OR IMPLIED, IS MADE INCLUDING, BUT NOT LIMITED TO, IMPLIED WARRANTIES OR MERCHANTABILITY AND FITNESS FOR A PARTICULAR PURPOSE. Nothing contained herein shall be construed as a license to operate under or recommendation to infringe any patents.

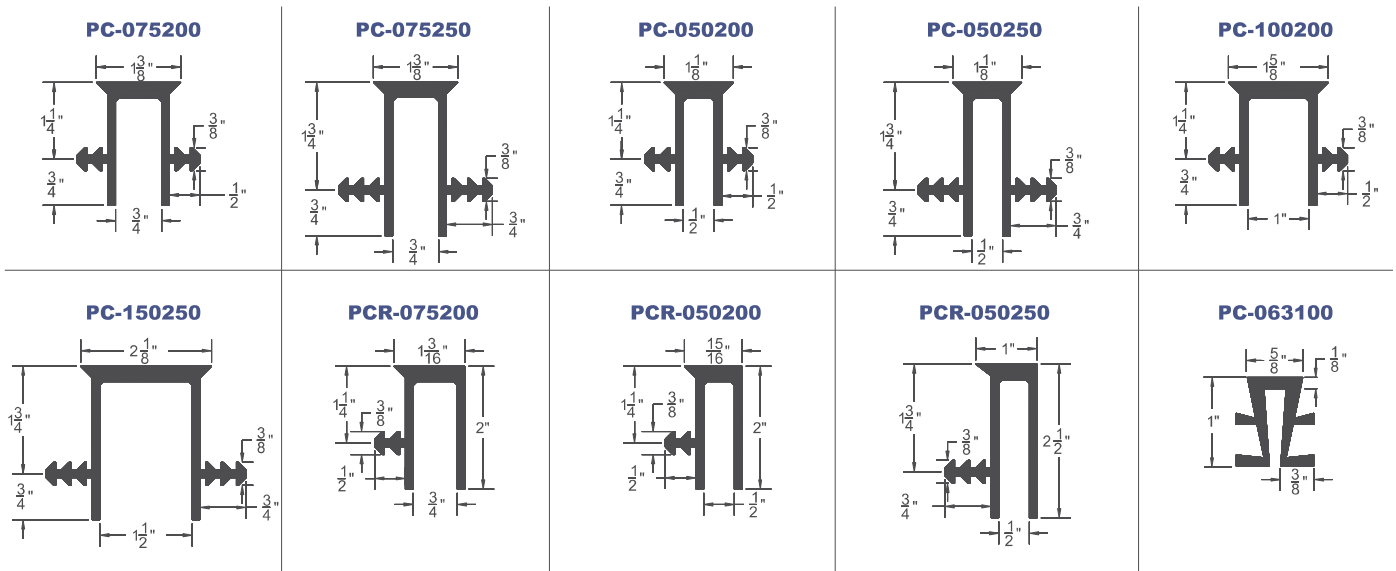

## HYDROPHILIC CHLOROPRENE RUBBER

- FEATURES:**
- Controlled Swell
  - Non-Bentonite
  - Good chemical resistance
  - High hydrostatic pressure



**COMMON APPLICATIONS:**

- Cast-in-place joints (100psi)
- Standard precast concrete joints (30psi)
- Precast tunnel segments (75psi)

**PROJECT TYPE EXAMPLES:**

- Retaining Walls
- Storage Tanks
- Water Treatment
- Waste Water
- Foundations
- Slab on Grade

**AVAILABLE DIMENSIONS:**

**HS-1020CR** 3/8" x 3/4" x 25' - 8 rolls/case (200ft)

**HS-0725CR** 5/16" x 1" x 25' - 6 rolls/case (150ft)

## HYDROPHILIC ELASTOMERIC SEALANT

- FEATURES:**
- Swells upon contact with water
  - Single component application
  - Excellent for new construction
  - Suitable for repair application
  - Works well with precast
  - Swells up to 100% in 7 days
  - Resists hydrostatic pressure to 60psi
  - Adhesive and weld properties



**HS-201P-20** (20.2oz. pack)

## BUTYL RUBBER HYDROPHILIC

- FEATURES:**
- Provides watertight seal in cold joints
  - Controlled swell on contact with water
  - Penetrates into poorly consolidated surfaces



**COMMON APPLICATIONS:**

- New or existing non-moving construction joints
- Through wall penetrations
- Depths of up to 100 feet

**PROJECT TYPE EXAMPLES:**

- Water treatment facilities
- Waste water treatment facilities
- Tunnels and vaults
- Manholes, culverts, slabs

**AVAILABLE DIMENSIONS:**

**HS-101** 3/4" x 1" x 16.8' - 6 rolls/case (100ft)

**HS-101T** 1" Trapezoid x 21' - 6 rolls/case (126ft)

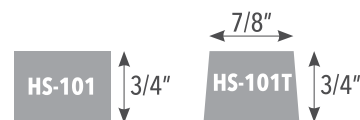



**BUTYL RUBBER NON HYDROPHILIC**



- FEATURES:**
- Self-sealing plastic adhesive compound
  - Bonds to cured concrete
  - Fuses with fresh concrete while curing for water tight seal
  - Unaffected by rain, snow or existing ground water

**PROJECT TYPE EXAMPLES:**

- Cold joints in highway tunnels
- Parking garages
- Office buildings
- Hospitals
- Sports complexes
- Enclosed potable reservoirs
- Wastewater plants



**AVAILABLE DIMENSIONS:**

**HS-302NS** 1-1/4" x 1" x 36" - (75ft box)

**FUEL RESISTANT**



- FEATURES:**
- Non Swell
  - Permanently flexible maintaining watertight joints
  - Will not harden or shrink over time
  - Installation is possible between 20° to 120° F

**COMMON APPLICATIONS:**

- Suitable for applications with possible exposure to: Gasoline, Jet A Fuel, JP-4 Fuel, JP-8 Fuel, Kerosene, Methyl Ethyl Ketone, Runway De-Icers, Diesel

**PROJECT TYPE EXAMPLES:**

- Airports
- Transportation facilities
- Fuel storage

**AVAILABLE DIMENSIONS:**

**HS-312FR** 7/8" x 7/8" x 14.5' - 8 rolls/case (116ft)

**PRIMER ADHESIVES**



Use with Mastic Non-Hydrophilic applications. Brush on application. Creates a bond and adhesion between concrete and preformed sealant.

**SOLVENT BASED**

**HS-311PS** (4) 1 gal. pails/case

**WATER BASED**

**HS-300PW** (4) 1 gal. pails/case

## USES

- ❖ Used in concrete flatwork as a control or construction joint
- ❖ Tongue & Groove design provides excellent load transfer characteristics
- ❖ Used as a screed rail to finish the concrete

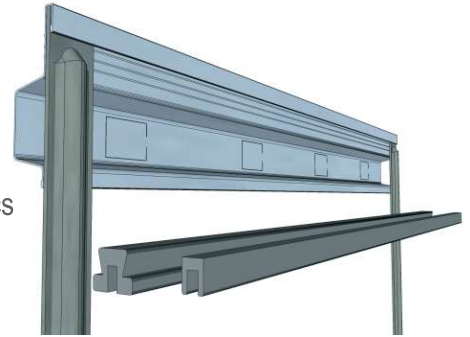

## ADVANTAGES

- ❖ Quickey™ is only galvanized joint system that features knockouts for square dowels, which provide better load transfer over round dowels & also reduces edge curl on the slab.
- ❖ Knockouts sizes meet both ACI and PCA recommendations for the design of tongue and groove key joint
- ❖ Saves on installation time... stake quickly interlocks at any point with key joint, reducing to place stakes precisely.
- ❖ Stiffened ribs are designed for increased rigidity while installing
- ❖ LOCKING-TAB™ stakes provide a positive interlock between stake & key joint to eliminates floating or rising from the stake, minimizing high spots.
- ❖ Stake profile features a non-twist design with allows the stake to be driven at a straight angle



Installation  
Video

## MATERIAL

- ❖ Quickey™ Keyway is made from 24 gauge G60 HDMG Steel
- ❖ Square knockouts every 6 inches
- ❖ Available in 10ft lengths for 4", 5", 6", 8" & 10-12" slabs
  
- ❖ LOCKING-TAB™ Stakes takes are made from 14-gauge HRPO steel
- ❖ Available in 12" (QK12), 15" (QK15), 18" (QK18), 24 (QK24) & 30" (QK30) lengths
- ❖ Removable and Non-Removable Keyway caps are made from Flexible PVC materials



# QUICKEY™ SYSTEM

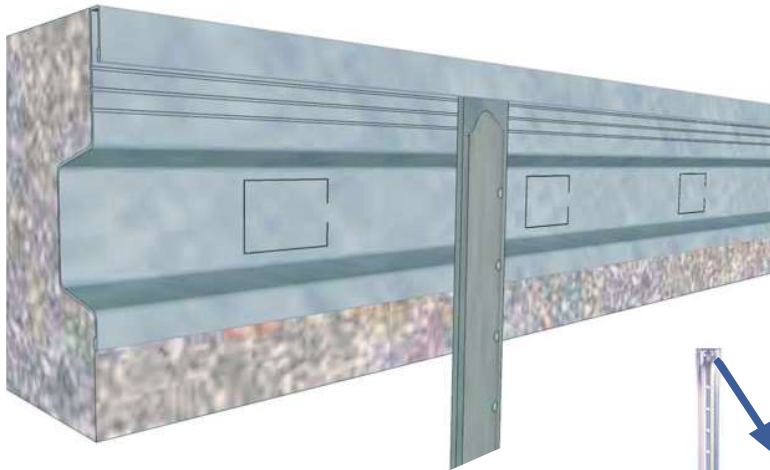

Stake **QUICKLY** interlocks at any point with Quickey, **REDUCING** time to place stakes precisely.

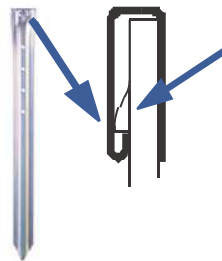

Inserting **LOCKING-TAB™** stakes produces an audible click which indicates the interlock between stake and key joint.

Keyway

Quickey™ PVC Removable Cap yields straight void ready for sealing.

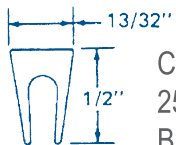
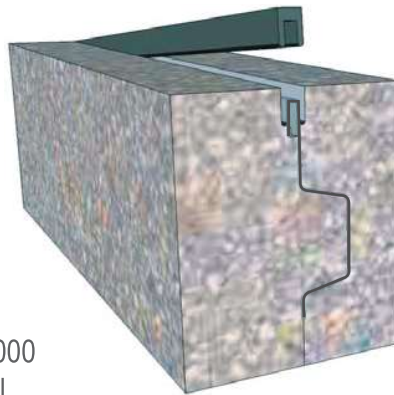

Cat# 2000  
250' roll  
Black

Quickey™ PVC Non-Removable Cap seals the joint because it stays in place.

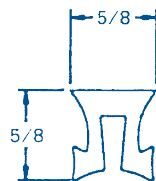
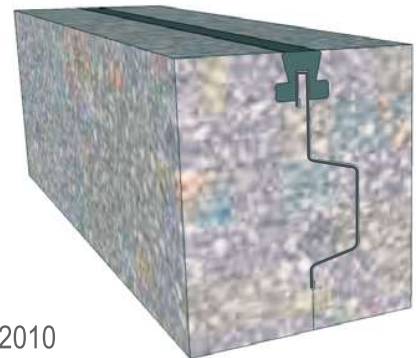

Cat# 2010  
200' roll  
Gray



Quickey™ Splice  
Cat# 2020  
200ea / box



Quickey™ Clip  
Cat# 2021  
200ea / box

Cat. #	Slab Thickness	A	B	C	Knockout Size
QK35	4"	3 1/8"	2"	3/4"	7/8" x 1 3/8"
QK45	5"	4 1/8"	2 1/2"	3/4"	7/8" x 1 3/8"
QK55	6"	5 1/8"	3"	3/4"	1 1/4" x 1 1/2"
QK75	8"	7 1/8"	4"	1"	1 1/4" x 1 1/2"
QK95	10" - 12"	9 1/8"	5"	1"	1 1/4" x 1 1/2"

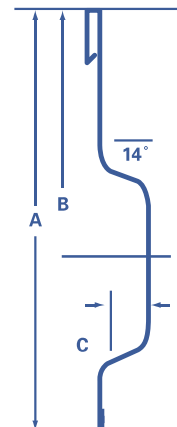



**USES**

- ❖ Used in concrete flatwork as a control or construction joint
- ❖ Tongue & Groove design provides excellent load transfer characteristics
- ❖ Used as a screed rail to finish the concrete

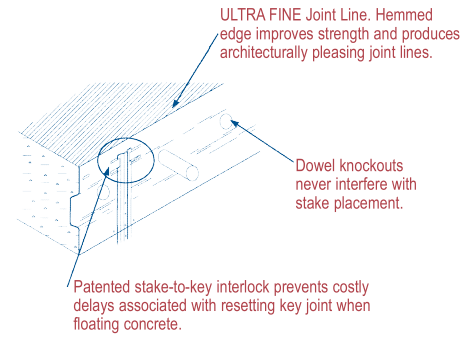

**ADVANTAGES**

- ❖ Positive stake-to-key lock of PRO-KEY™ prevents costly delays associated with resetting key joint when floating concrete. Stakes interlock with slots to prevent the key form rising off the stakes.
- ❖ Location of the key is 1/2 depth of slab as specified by ACI & PCA
- ❖ Radius formed key eliminates the sharp angles that produce spalling tendency.
- ❖ ULTRA FINE profile at top edge eliminates surface voids, reduced spalling and produces architecturally pleasing joint lines in the finished slab.
- ❖ PRO-KEY™ LOCK-SLOT™ Stakes double as a butt splice

**MATERIAL**

- ❖ PRO-KEY™ Keyway is made from 24 gauge G60 HDMG Steel
- ❖ Dowel knockouts every 6 inches
- ❖ Available in 10ft lengths for 4", 5", 6" 8" & 10-12" slabs
- ❖ LOCK-SLOT™ Stakes are made from 16 gauge HRPO steel
- ❖ Available in 12" (1200), 15" (1500), 18" (1800) and 24" (2400) lengths
- ❖ Removable Keyway caps are made from Flexible PVC materials

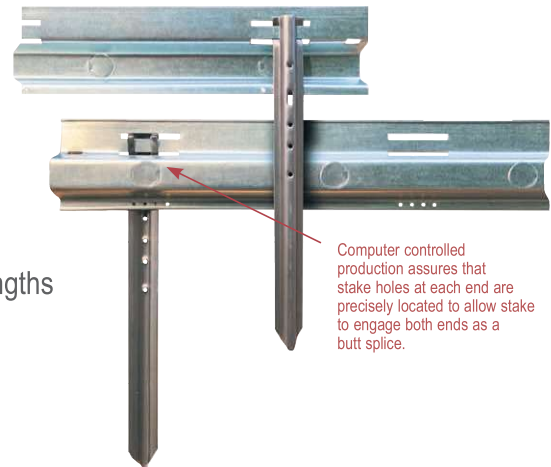

PRO-KEY™ removable cap yields straight void ready for sealing

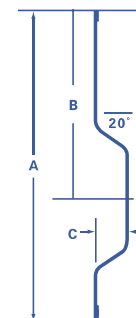
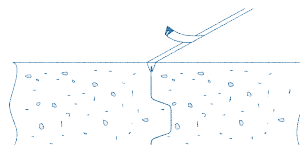
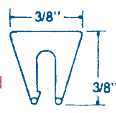

Installation Video

Cat. #	Slab Thickness	A	B	C	Knockout Dia.
3500	4"	3 1/8"	2"	3/4"	7/8"
4500	5"	4 1/8"	2 1/2"	3/4"	7/8"
5500	6"	5 1/8"	3"	3/4"	7/8"
7500	8"	7 1/8"	4"	3/4"	1 1/4"
9500	10" - 12"	9 1/8"	5"	3/4"	1 1/4"

## KEYWAY INSTALLATION

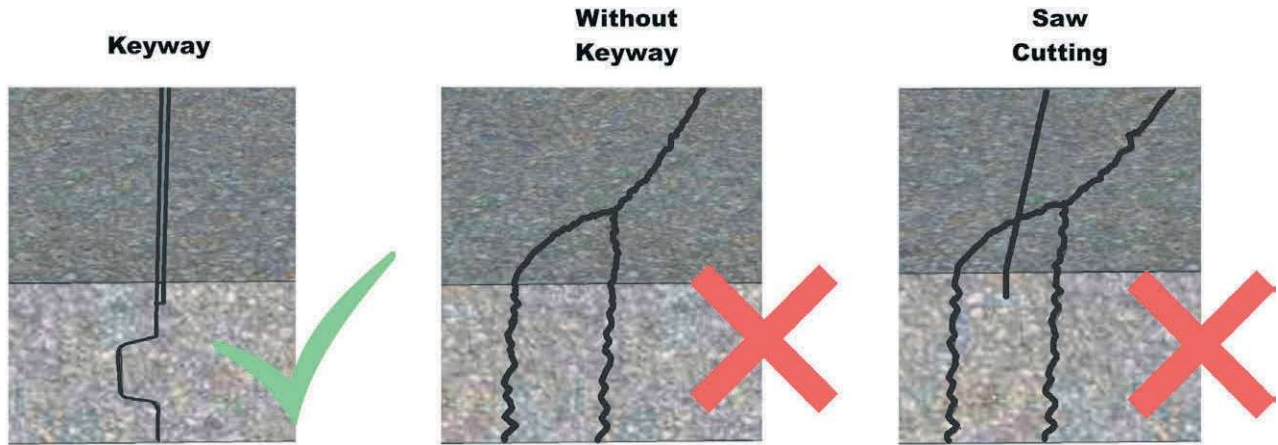

Keyway

## METAL NAIL-ON KEYWAY

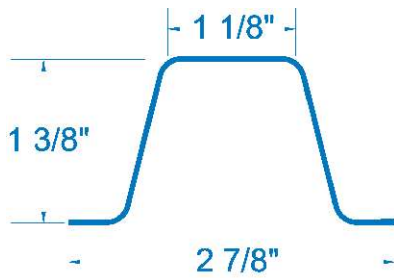

- Made of high quality hot dipped mill galvanized steel
- A 1:4 slope that meets both ACI & PCI recommendations
- Folded over to eliminate sharp edges
- All knockouts are on 6" center
- Two knockout size of 9/16" (MNK) or 7/8" (MNK-78)
- 5,000ft/sk, 25 bundles of 200ft ea, 10ft lengths

## PLASTIC NAIL-ON KEYWAY

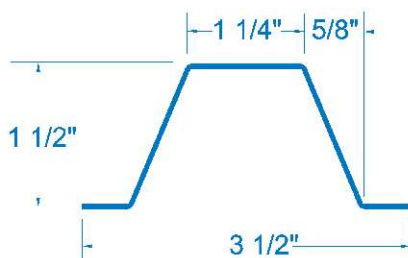

- Plastic Nail-On Keyway (PNK) is nailed to a form prior to pouring
- Installed in tilt-up work, industrial floors, curbs or wherever specified
- Simple to use, lightweight and reusable
- BoMetals quality that you've come to recognize
- 10-foot lengths, 400 feet per box

## HIGHWAY CENTER STRIP KEYWAY SYSTEM

### USES

- ❖ Used in concrete flatwork as a control or construction joint
- ❖ Tongue & Groove design provides excellent load transfer characteristics
- ❖ Used as a screed rail to finish the concrete

### ADVANTAGES

- ❖ Eliminates costly form stripping and saw cutting.
- ❖ Radius formed key eliminates the sharp angles that produce spalling tendency
- ❖ ULTRA FINE profile at top edge eliminates surface voids, reduced spalling and produces architecturally pleasing joint lines in the finished slab.
- ❖ Channel Stakes double as a butt splice

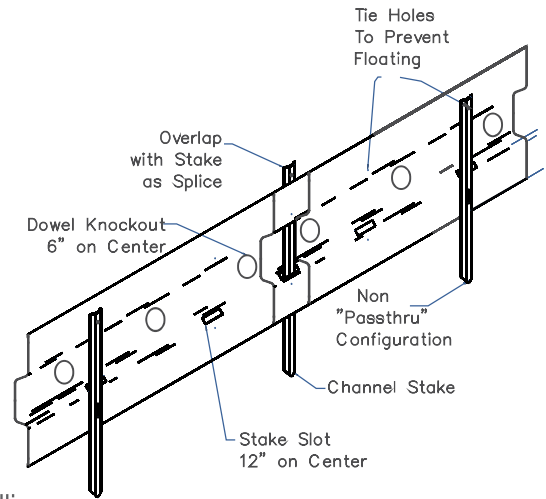

### MATERIAL

- ❖ Keyway is made from 20 gauge HDMG Steel
- ❖ Dowel knockouts every 6 inches
- ❖ Available in 10ft lengths for 5", 6" 8" 9" & 10" slabs
- ❖ Channel Stakes are made from 16 gauge HRPO steel
- ❖ Available in 15" (HK15) lengths



Product Code	Slab Thickness	A	B	C	Knockout Diameter
HK45	5"	4 1/2"	2 3/4"	1"	7/8"
HK55	6"	5 1/2"	2 7/8"	1"	7/8"
HK65	7"	6 1/2"	3"	1"	7/8"
HK75	8"	7 1/2"	3 1/4"	1"	1 1/4"
HK85	9"	8 1/2"	3 1/2"	1"	1 1/4"
HK95	10"	9 1/2"	3 3/4"	1"	1 1/4"

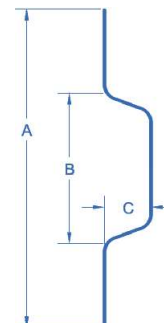

## RECESS KEY PRODUCT LINE

BoMetals **RECESS KEY** Product Line is used to make a key in the concrete to provide load transfer across the concrete joint. BoMetals is proud to announce that we have 3 different types of Recess Key. The main differences between the designs is dowel spacing. All Recess Key is made of 24 gauge and legs are made of 20 gauge hot dipped, mill galvanized steel. Recess Key with leg is also available which can be determined by the thickness of the concrete slab. All the different designs will have the same style profile as you see in Figure A. Minimum orders apply on some sizes.

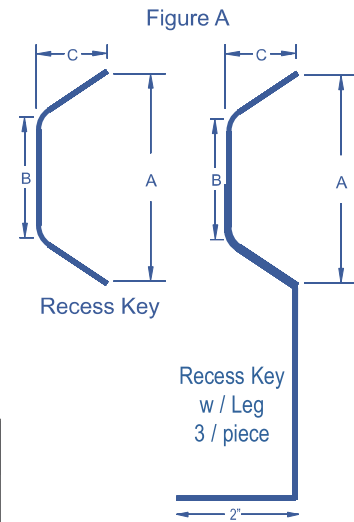

Recess Key	A	B	C	Hole Size
RK5	2 1/2"	1 1/2"	1"	7/8"
RK6	2 1/2"	1 1/2"	1"	1"

### UNIVERSAL KEY (RK) & UNIVERSAL KEY WITH LEG (RKL)

This design can use any 6" increment on center spacing whether you butt up the ends or overlap the first dowel holes.

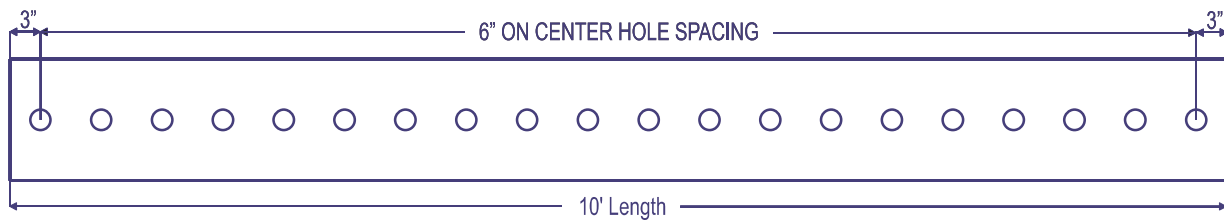

### MO-KEY (RKM) & MO-KEY WITH LEG (RKML)

This design would be used to butt the end together to maintain a 30" on center spacing through out the joint. Conforming to Missouri Configurations.

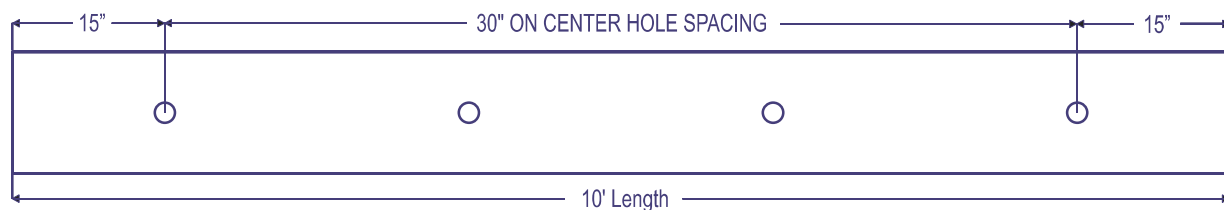



# The Cost Effective Solution for

Dowels

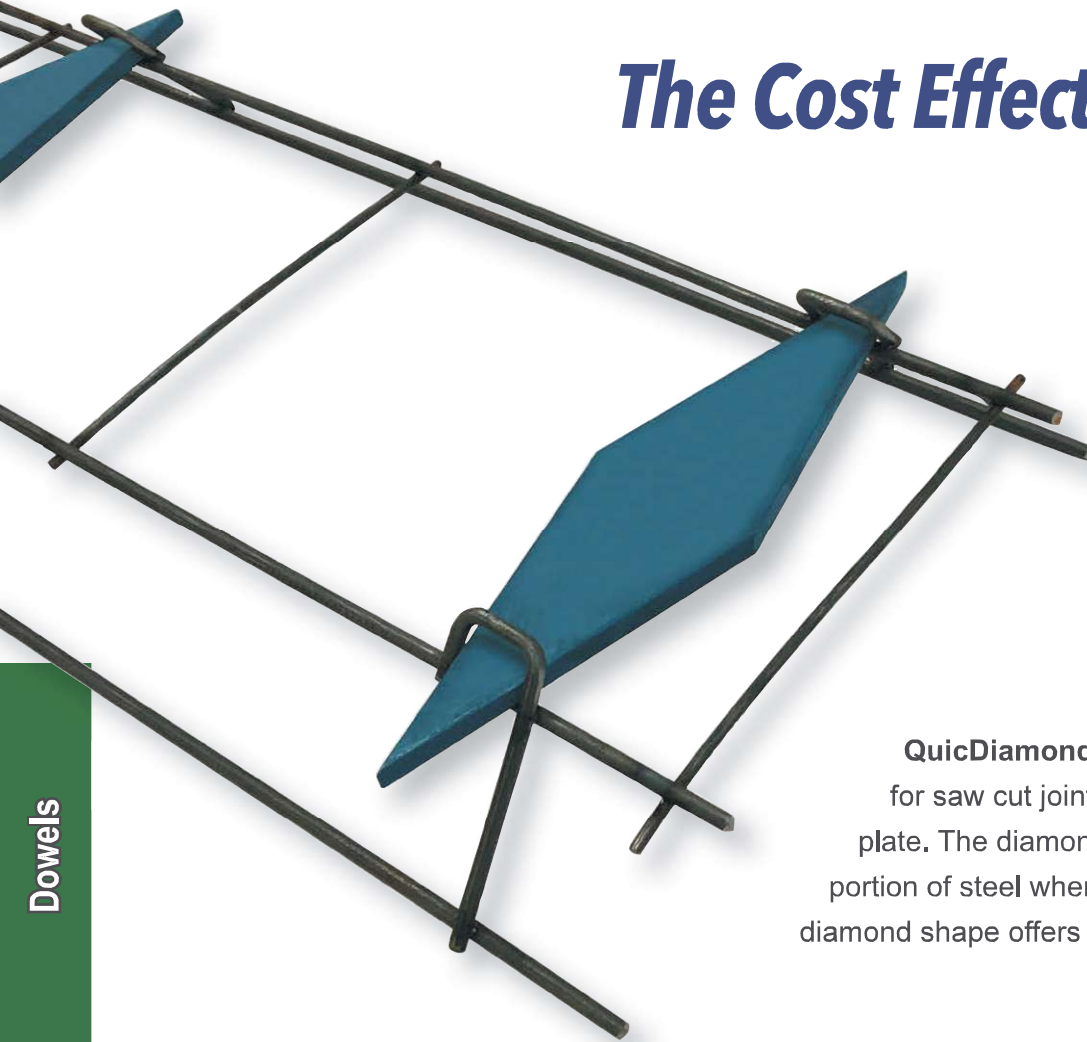

**QuicDiamond™ Basket** is the ideal solution for saw cut joints to optimize the steel in a flat plate. The diamond shape positions the widest portion of steel where it is needed most and the diamond shape offers the best in expansion flexibility.

## QuicDiamond™ Baskets

- Provides stable dowel support and alignment with fully-welded basket assemblies
- Custom baskets available through our distribution network
- All steel is sawn according to industry guidelines ensuring smooth plate edges that will ensure free movement of dowel
- Doweling method in accordance with ACI 360 Design of Slab-on-Ground
- Design accommodates axial and lateral slab movements rapidly
- Engineered to provide optimal use of steel
- Doweling method in accordance to ACI360
- Factory-applied debonding agent on all dowel plates
- All plates are manufactured from steel certified to meet ASTM A36
- Cross-sectional area of steel at the outside edge of the saw-cut installation tolerance
- Construction Tolerance is 2" from center for all dowels
- Can be placed closer to the intersection of joints (6") to mitigate curl more effectively.



# Slab on Grade – The QuicDiamond™ System



## Our QuicDiamond™ Dowel System

is the best solution for optimizing the steel in a flat plate dowel. The diamond shape positions the widest portion of steel where it is needed most and the diamond shape offers the best in expansion flexibility.

Dowels

## QuicDiamond™ Sleeves & Plates

- Provides excellent joint stability compared to other systems
- Provides reliable and maintenance-free concrete flatwork joints
- The plate shape is engineered for optimal material performance
- Plates are sawn steel for smooth square plate edges, allowing for unrestrained horizontal or lateral movement
- Consistently specified manufacturing tolerance
- Positive load transfer and continuity of surface profile
- Sleeves are manufactured from high-density ABS plastic
- Internal collapsible fins and spacers ensure load plate is installed in the correct position to preserve integrity of the sleeve
- Wide sleeve for increased lateral movement
- Plate shape allows for the most lateral and horizontal movement with maximum strength at the center of the joint
- Ribbed sleeves for increased rigidity
- Internal support stops sleeve compression during installs for sure and easy plate insertion

<b>QD-025</b>	1/4" x 4.5" x 4.5"
<b>QD-038</b>	3/8" x 4.5" x 4.5"
<b>QD-075</b>	3/4" x 4.5" x 4.5"

**Dowels**



QuicDiamond™ Plates for sleeves and  
QuicDiamond™ Baskets steel options:  
*Epoxy, Painted, Galvanized  
and Stainless Steel*



**EPOXY**

- Fusion Bonded Epoxy Powder Coating
- Protects steel from corrosion
- 8 mil epoxy coating

**PAINTED**

- Cost reducing corrosion protection with red oxide paint

**GALVANIZED**

- Hot dipped galvanized steel meets ASTM A 123/A and ASTM A385

**STAINLESS STEEL**

- Grade 304 stainless steel certified to meet ASTM A240

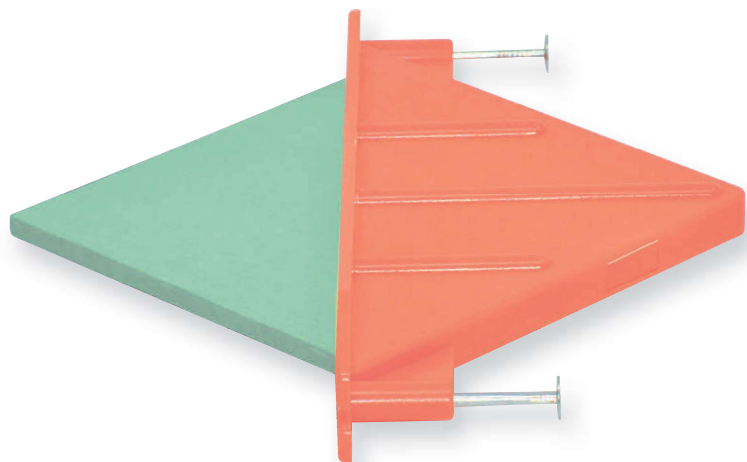



## ROUND DOWEL BASKETS



# Round Dowel Load Transfer Assemblies



- Round dowel load transfer assemblies are custom built to your specifications.
- Available for Contraction Joints, Expansion Joints and Longitudinal Joints
- Load Transfer Dowels: Smooth and Deformed sizes ½" to 2".
- Steel in baskets is A615-Grade 60
- Leg types available: J and A



- Manufactured using wire sizes .262, .306 and .362
- Epoxy coating to CRSI Standard ASTM A775 and ASTM 1078
- Other products available: Cures, Epoxies, Dowel Caps and Basket Stakes











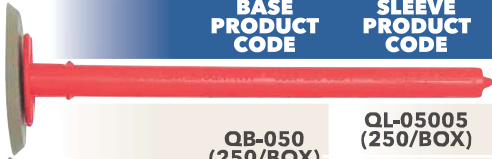

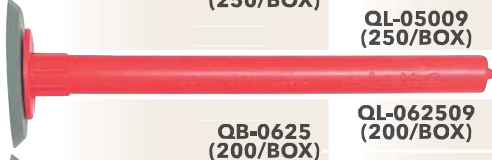

# QuicDowel™

A two component sleeve system made of high density polypropylene.

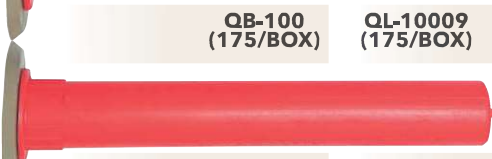
Dowels

	BASE PRODUCT CODE	SLEEVE PRODUCT CODE	SMOOTH ROUND	SLEEVE LENGTH	DOWEL LENGTH	REBAR SIZE	
	QB-050 (250/BOX)	QL-05005 (250/BOX)	1/2"	5"	10"	#3	
		QL-05009 (250/BOX)	1/2"	9"	18"	#3	
	QB-0625 (200/BOX)	QL-062509 (200/BOX)	5/8"	9"	18"	#4	
		QL-062512 (125/BOX)	5/8"	12"	24"	#4	
	QB-075 (200/BOX)	QL-07505 (200/BOX)	3/4"	5"	10"	#5	
		QL-07509 (200/BOX)	3/4"	9"	18"	#5	
		QL-07512 (125/BOX)	3/4"	12"	24"	#5	
	QB-100 (175/BOX)	QL-10009 (175/BOX)	1"	9"	18"	#7	
	QB-125 (125/BOX)	QL-12509 (125/BOX)	1 1/4"	9"	18"	#8	

# QuicLoad™



MADE IN USA

PRODUCT CODE	DIAMETER	SLEEVE LENGTH	DOWEL LENGTH	PKG
QL-05005	1/2"	5"	1/2" X 10"	250/BOX
QL-05009	1/2"	9"	1/2" X 18"	250/BOX
QL-062509	5/8"	9"	5/8" X 18"	200/BOX
QL-062512	5/8"	12"	5/8" X 24"	125/BOX
QL-07505	3/4"	5"	3/4" X 10"	200/BOX
QL-07509	3/4"	9"	3/4" X 18"	200/BOX
QL-07512	3/4"	12"	3/4" X 24"	125/BOX
QL-10009	1"	9"	1" X 18"	175/BOX
QL-12509	1 1/4"	9"	1 1/4" X 18"	125/BOX

## SMOOTH ROUND DOWELS

Meets ASTM A 615 Grade 60  
Steel & ACI 302. 1R-04 3.2.7



Product Code	Size	Weight/pc (lbs)	pcs/ bundle	pcs/ skid
SRD-05012	1/2"x12"	0.67	10	5,040
SRD-05018	1/2"x18"	1.00	10	3,640
SRD-05024	1/2"x24"	1.34	10	2,400
SRD-062512	5/8"x12"	1.05	10	3,240
SRD-062518	5/8"x18"	1.57	10	2,160
SRD-062524	5/8"x24"	2.09	10	1,280
SRD-07512	3/4"x12"	1.50	10	2,400
SRD-07518	3/4"x18"	2.26	10	1,600
SRD-07524	3/4"x24"	3.01	10	1,040
SRD-10012	1"x12"	2.67	5	1,200
SRD-10018	1"x18"	4.01	5	800
SRD-10024	1"x24"	5.34	5	650
SRD-12518	1-1/4"x18"	6.26	5	480
SRD-12524	1-1/4"x24"	8.35	5	400
SRD-15018	1.5"x18"	9.02	5	320
SRD-15024	1.5"x24"	12.01	5	240

- Sawn for close tolerances & Computerized Length
- Custom diameters & lengths available
- Additional dowels finishes: Epoxy, Painted, Galvanized, and Stainless Steel
- All of our dowel bundles are labeled for quick identification of size on the jobsite.



## STANDARD NON CROSSLINKED FOAM



### APPLICATIONS:

BoMetals Foam (FEJ) expansion joint filler can be used in all standard concrete construction, such as highway, runways, parking garages, driveways, sidewalks, and floor slabs.

BoMetals Foam can also be used as a buffer between dissimilar materials such as columns, manhole covers, and adjacent constructions.

### FEATURES:

- BoMetals Foam – Extruded from a high quality, closed cell Non-Crosslinked polyethylene foam
- Tear-Off Strip – Standard on each roll but can be special ordered without
- Flexibility – Will not break or crack when used around curves or columns
- Lightweight – Approximately 10 times lighter than traditional expansion joint products
- Accepted – Currently used by both residential and commercial contractors
- Durable – With near zero water absorption, BoMetals Foam will not rot over time
- Economical – Easily cut and handled on any jobsite

Physical Properties	Test Method	Value*
Recovery (%)	ASTM D545-05	97.8%
Extrusion (in)	ASTM D545-05	0.12
Compressive Strength (psi)	ASTM D545-05 @ 50%	14.9
Compression Set (%)	ASTM D3575-00 Suffix B	18.3%
Tensile Stress (psi)	ASTM D3575-00 Suffix T	103 / 68
Tear Resistance (lb/in) md/cmd	ASTM D3575-00 Suffix G	14 / 24
Density (lb/ft <sup>3</sup> )	ASTM D3575-00	1.7 (nominal)
Water Absorption (lb/ft <sup>2</sup> )	ASTM 545-00	0.001
Meets Application Requirements of: ASTM D 4819 Type II		

\* While values shown are typical of these products, they should not be construed as specification limits

Standard Packaging	
Colors*	Gray
Thicknesses*	1/4", 3/8", 1/2", 3/4", 1", 2", 3"
Width (Height)*	2" to 48"
Length of 1/4" Rolls	100'
Length of 3/8", 1/2" Rolls	50'
Length of Planks	9'

\* Some exceptions apply. Custom thicknesses, and widths available, please inquire about availability and lead times.



## DOVETAIL ANCHOR SLOT & DOVETAIL ANCHORS

PRO-SLOT™ Anchor Slot is a stay-in-place concrete form used in forming a channel into the face of any cast in place wall or column. By installing Dovetail Anchors into the PRO-SLOT™, you can then anchor brick, block or stone to the concrete surface.

### Material

BoMetals galvanized PRO-SLOT™ Anchor Slot is manufactured of G60 hot dipped mill galvanized steel in 26, 24, 22, 20 and 18 gauge. PRO-SLOT™ is offered standard in 10' lengths with custom lengths available on a special order basis. BoMetals' PRO-SLOT™ is standard with a polystyrene foam filler to keep the channel clear of concrete and resist closure due to hydraulic pressure. It is also available without a polystyrene foam. PRO-SLOT™ incorporates continuous nail grooves along the back edge of the profile to help in nailing the slot to the forms.

Dovetail Anchors are manufactured in 16 gauge hot dipped, mill galvanized steel and are furnished in 3 1/2", 5 1/2" and 7 1/2" lengths with a 1" overall width.

PRO-SLOT™ Anchor Slot and Dovetail Anchors are mill galvanized before fabrication and conform to ASTM A 924, ASTM A 653 CQ or LFQ.

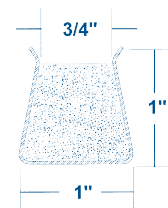
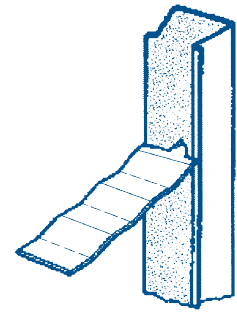

### Advantages

- ❖ PRO-SLOT™ Anchor Slot and Dovetail Anchors provide a permanent, fast, flexible and cost effective method of anchoring brick, stone and block to cast-in-place concrete walls and columns.
- ❖ PRO-SLOT™ provides an excellent anchoring system for both cast-in-place and precast concrete.
- ❖ With a heavy, galvanized coating to prevent corrosion, Dovetail Anchors have deep corrugations to increase pull out strength.

### Installation Instructions

- ❖ Nail BoMetals' PRO-SLOT™ Anchor Slot to the inside of the form wall prior to erection. Install vertically, spacing the channels 16", 18" or 24" on center. Use the nail grooves to speed up installation and space nails on 12" center.
- ❖ Dovetail Anchors should be spaced as indicated on drawings or called for in specifications or as recommended by local building codes. Typically, Anchors are spaced 12" to 16" vertically.

Product	Color Code	Description	Feet / Skid	# / Skid
DAS-18*	ORANGE	18ga Anchor Slot STANDARD 10' long	6,000'	2,933
DAS-20*	YELLOW	20ga Anchor Slot STANDARD 10' long	6,000'	2,247
DAS-22*	GREEN	22ga Anchor Slot STANDARD 10' long	6,000'	1,873
DAS-24*	BLUE	24ga Anchor Slot STANDARD 10' long	6,000'	1,508
DAS-26*	RED	26ga Anchor Slot STANDARD 10' long	6,000'	1,068

DOVETAIL ANCHORS 16 GAUGE		
DTA-35 3 1/2" (500 / box)	DTA-55 5 1/2" (500 / box)	DTA-75 7 1/2" (300 / box)

\*Custom lengths are available. Please call 800.862.4835 for information.

Accessories – DAS



## STANDARD BACKER ROD



BoMetals Standard Backer Rod (FBR) is a ideal non absorbent compressible polyethylene material inserted into a joint to control sealant depth, creating a backstop to allow proper sealant tooling. It can also be used as a temporary joint seal.

### Technical Data

Sealant Use	Cold-Applied	
Absorption	Non-Absorbing	
Out-Gassing	Out-Gassing*	
Temperature Range	-45°F to +160°F	ASTM D 5549 Type 3
*When punctured		

## NEOPRENE SPONGE RUBBER WITH/WITHOUT PSA



BoMetals Neoprene Sponge Rubber is used to help prevent clogging of expansion joint with mortar and is accepted for brick and block expansion joint fillers.

### Technical Data

Density	4.5 PCF	
Compression Deflection	4 PSI @ 25%	
Water Absorption	5% by weight	
Flame Resistance (FMVSS302)	PASS	
***Multiple Densities/Types Available		ASTM D 1056 Specification

## AASHTO & COMMERCIAL BEARING PAD



BoMetals Bearing Pad is used in variety of applications like absorb vibration and prevent sound transfer, while reducing the destructive action of vibration between movable and stationary members.

AASHTO Grade - AASHTO-M-251

Commercial Grade

## STANDARD & SELF EXPANDING CORK



### Standard Cork:

BoMetals Standard Cork used as joint filler for roads, bridge and traffic surfaces.

ASTM D 1752-84 TYPE II

### Self Expanding Cork:

BoMetals Self Expanding Cork is used for sealing the expansion joints in water structures, irrigation canals, culverts, dams & etc.

ASTM D 1752-84 TYPE III

## MASONRY CONTROL JOINTS

Cracking in buildings normally results from restrained movement. This movement may originate within a building material due to temperature change or shrinkage, or may result from movement of adjacent building elements. In most cases, movement is inevitable and must be accounted for during design if cracking is to be controlled.

BoMetals Control joints, when placed in concrete masonry walls, are an excellent method of crack control. Control joints are vertical separations built into a concrete masonry wall to reduce restraint and permit longitudinal movement. They are located where cracking is likely to occur due to excessive tensile stress.

### Material

BoMetals Masonry Control Joints are available in both PVC and Rubber compounds. They are standard 4' lengths. Special lengths are available on request.



### TYPICAL PHYSICAL PROPERTIES OF PVC CONTROL JOINTS, ASTM D-2287

Properties	Test Method	Nominal Value
Tensile Strength	ASTM D-638	1500 PSI
Elongation	ASTM D-638	300%
Specific Gravity	ASTM D-792	1.40 (+/-0.05)
Hardness Shore A	ASTM D-2240	85 +/- 5

### TYPICAL PHYSICAL PROPERTIES OF RUBBER CONTROL JOINTS

Properties	Test Method	Nominal Value
Tensile Strength	ASTM D-2000	750 PSI
Elongation	ASTM D-2000	300%
Hardness Shore A	ASTM D-2000	70 (+/-5)

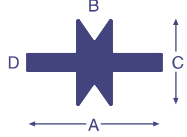
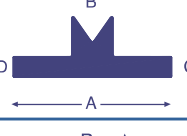
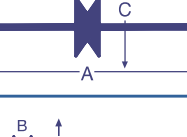
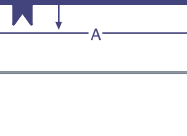
IMPORTANT: The technical data herein is believed to be accurate. It is offered for your consideration, investigation and verification. All testing and test data has been prepared by independent laboratories. NO WARRANTY, EXPRESS OR IMPLIED, IS MADE as to the accuracy or completeness of the technical data herein and the use thereof for any particular purpose.

Catalog #	Material	A	B	C	D	#Lbs./LF	Description
BCJ-1	PVC	2 3/8"	5/8"	1 1/2"	5/16"	.75	
BCJ-8	Rubber	2 3/8"	5/8"	1 1/2"	5/16"	.52	
BCJ-2	PVC	2 3/8"	5/8"	9/16"	5/16"	.60	
BCJ-9	Rubber	2 3/8"	5/8"	9/16"	5/16"	.42	
BCJ-3	PVC	6 7/8"	5/8"	1 1/2"	3/8"	1.00	
BCJ-10	Rubber	6 7/8"	5/8"	1 1/2"	3/8"	.69	
BCJ-4	PVC	10 7/8"	5/8"	1 1/2"	7/16"	1.35	
BCJ-11	Rubber	10 7/8"	5/8"	1 1/2"	7/16"	.94	

## JOINT FORMERS

### EXPANSION BOARD CAPS

Expansion Board Caps provide clean, sharp lines for sealants. They eliminate the difficulty of removing wooden formers.

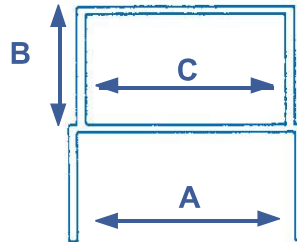
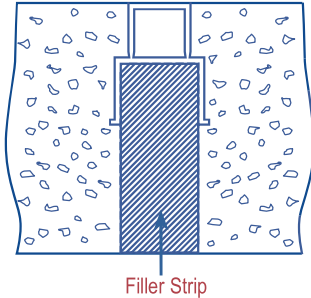

Cat. #	A	B	C
1018	3/8"	3/8"	5/16"
1019	1/2"	3/8"	5/16"
1020	1/2"	1/2"	7/16"
1021	3/4"	1/2"	5/8"
1022	1"	1/2"	7/8"

### ZIP JOINTS

Zip Joints are easily installed joint formers designed to provide positive control of transverse construction or expansion joints. The two-part assembly is designed to permit removal of the top portion after the concrete has hardened, thereby creating a clean, neatly defined void for application of caulk or sealant when specified.

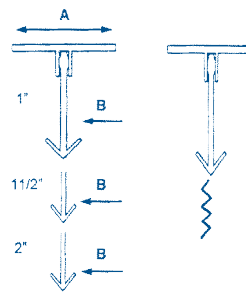

Cat. #	A	B
1010	1"	1"
1011	1"	1 1/2"
1012	1"	2"

## WEEP TUBES

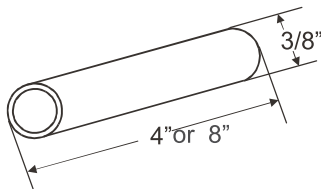

BoMetals Weep Tubes shall be placed to insure that they are correctly positioned in the masonry joint to guarantee air movement from the cavity to the outside of the wall. Typical placement would be for the one end of the weep tube to be flush with the outside of the joint and the opposite end to project into the cavity of the wall. Typical locations would be no greater than 24" on center. Care should be taken during mortar placement to prevent excessive movement of the weep tubes to insure against displacement. Always thoroughly and systematically inspect mortar around the weep tubes to make certain that the weep tube is free from obstruction.

## BAR FOUNDATION CHAIRS

Bar Foundation Chairs are widely used to support rebar when pouring footers. They are simple to use, inexpensive, and convenient. As you see below, we have a 2-Bar and a 3-Bar manufactured from 12-gauge wire. There are 100 per box.

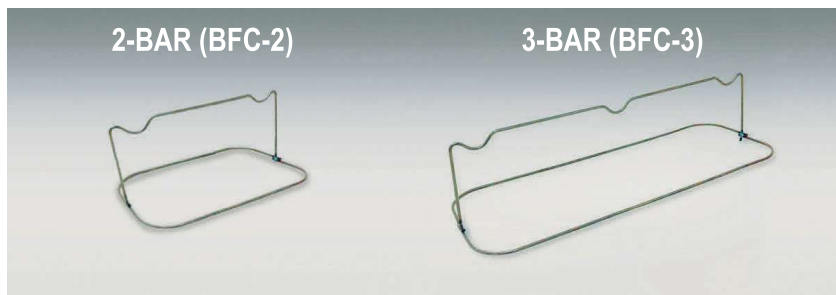

2-BAR (BFC-2)

3-BAR (BFC-3)

8" wide x 3" high  
Bar supports at 6" spacing

12" wide x 3" high  
Bar supports at 5" spacing

## FLEXIBLE PVC CHAMFER AND RADIUS FORMERS

BoMetals Chamfer and Radius formers are designed to create outside corners on columns, piers, beams or walls and provide a clean, smooth finished edge.

<p><b>1/2" Chamfer Former</b> CS -500</p> <p>500 ft./roll 42 lbs</p>	<p><b>1/2" Chamfer Former w/Leg</b> CL -500</p> <p>10 ft. length 500 ft./ctn 54 lbs</p>	<p><b>1/2" Radius Former w/Leg</b> RL -500</p> <p>10 ft. length 500 ft./ctn 33 lbs</p>
<p><b>3/4" Chamfer Former</b> CS -750</p> <p>200 ft./roll 39 lbs</p>	<p><b>3/4" Chamfer Former w/Leg</b> CL -750</p> <p>10 ft. length 300 ft./ctn 68 lbs</p>	<p><b>3/4" Radius Former w/Leg</b> RL -750</p> <p>10 ft. length 300 ft./ctn 39 lbs</p>
<p><b>1" Chamfer Former</b> CS -1000</p> <p>10 ft. length 300 ft./ctn 101 lbs</p>	<p><b>1" Chamfer Former w/Leg</b> CL -1000</p> <p>10 ft. length 300 ft./ctn 116 lbs</p>	<p><b>1" Radius Former w/Leg</b> RL -1000</p> <p>10 ft. length 300 ft./ctn 59 lbs</p>
<p><b>1-1/2" Chamfer Former</b> CS -1500</p> <p>10 ft. length 150 ft./ctn 113 lbs</p>	<p><b>1-1/2" Chamfer Former w/Leg</b> CL -1500</p> <p>10 ft. length 150 ft./ctn 121 lbs</p>	<p><b>1-1/2" Radius Former w/Leg</b> RL -1500</p> <p>10 ft. length 150 ft./ctn 56 lbs</p>
<p><b>2" Chamfer Former</b> CS -2000</p> <p>10 ft. length 100 ft./ctn 134 lbs</p>	<p><b>2" Chamfer Former w/Leg</b> CL -2000</p> <p>10 ft. length 100 ft./ctn 139 lbs</p>	<p><b>2" Radius Former w/Leg</b> RL -2000</p> <p>10 ft. length 100 ft./ctn 63 lbs</p>

## DRIP STRIP

BoMetals Drip Strips are designed to provide an even, smooth drip groove on the underside of porches and overhangs. The Drip Strip is nailed to the form and easily removed from the concrete to be reused in your next application.

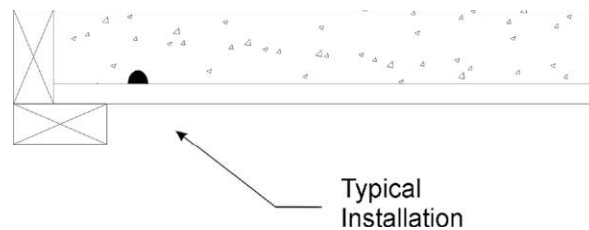
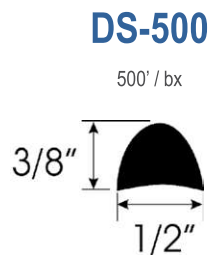
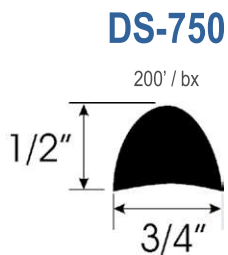



## CONCRETE ACCESSORIES

### ELEPHANT TRUNK

Size	Part #	Weight / Roll
8' x 50'	ET-08	44#
12" x 50'	ET-12	65#



### HOPPERS

Size	Discharge	Part #	Weight
36" x 36" Reinforced	8" - 12"	HPR-HD Heavy Duty	18#

#### Reinforced, Heavy Duty Hopper 8"/12"

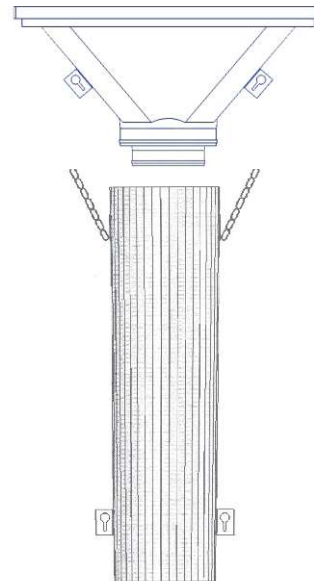

### PVC TREMIE PIPE

Size	Part #	Weight
8" dia. x 4'	TP-08	9#
12" dia. x 4'	TP-12	11#

They taper from 9" to 8" or from 13" to 12".

### ELEPHANT TRUNK STEEL COLLARS

Size	Part #	Weight
8"	ETC-08	4#
12"	ETC-12	5#

Supplied with chains to quickly attach and detach Elephant Trunks from the Hopper.



### STEEL ADJUSTABLE BAND CLAMPS

Size	Part #	Weight
Fits 8" - 12" discharge	ETB	1#

## PREMIUM NAIL STAKES - FULL SIZE

BoMetals Nail Stakes are primarily used to secure wood or metal forms for concrete placement jobs and in outside concrete forming.



### 3/4" Full Size, High Tensile, Round with Holes

Code	Size	pcs / skid	wt / skid
NS-3412	3/4" x 12"	1500	2,100
NS-3418	3/4" x 18"	1000	2,100
NS-3424	3/4" x 24"	750	2,175
NS-3430	3/4" x 30"	600	2,100
NS-3436	3/4" x 36"	500	2,150
NS-3442	3/4" x 42"	400	2,000
NS-3448	3/4" x 48"	300	1,710

### 7/8" Full Size, High Tensile, Round with Holes

Code	Size	pcs / skid	wt / skid
NS-7812	7/8" x 12"	1500	2,226
NS-7818	7/8" x 18"	1000	2,226
NS-7824	7/8" x 24"	750	2,305
NS-7830	7/8" x 30"	600	2,226
NS-7836	7/8" x 36"	500	2,279
NS-7842	7/8" x 42"	400	2,120
NS-7848	7/8" x 48"	300	1,815

## GRADE STAKES

- Pre drilled holes for tie wire
- Termite proof
- Each stake has a pointed, sharp tip for easy installation
- Will not split like wood
- Can be used as rebar support
- Available in 12" (GS-12) , 18" (GS-18), 24" (GS-24) or 30" (GS-30) lengths
- 100 pieces per box
- Made from 16 gauge HRPO steel



## WIRE BAR STAKES

### 2 BAR WIRE STAKE WBS-1

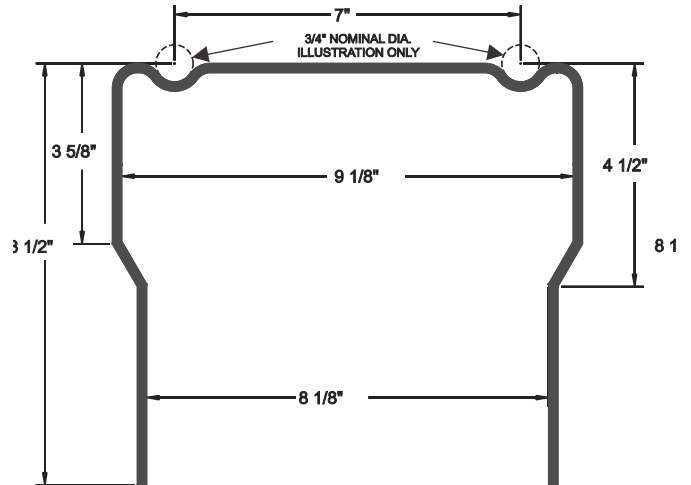

### 3/16" Nominal Wire - 100 per box

### 2 BAR WIRE STAKE WBS-2

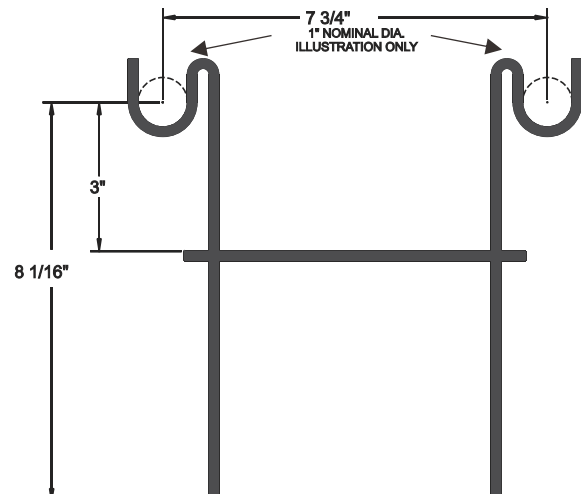

# BoMetals, inc.®

concrete and masonry accessories



All BoMetals products are available through a national network of distributors and warehouses. A trained and knowledgeable sales and engineering staff offer personalized service unparalleled in the industry today.

- ◆ **Carrollton, GA Manufacturing Facility** ◆
- ◆ **Chicago, IL Warehouse** ◆
- ◆ **Houston, TX Warehouse** ◆
- ◆ **Worldwide Distribution** ◆

141 Hammond Street ◆ Carrollton, GA 30117  
Toll Free: 1-800-862-4835 ◆ Phone: 770-832-2000 ◆ Fax: 770-832-2095  
[www.bometals.com](http://www.bometals.com) ◆ [info@bometals.com](mailto:info@bometals.com)